

METALMASTER

OPERATION MANUAL



HYDRAULIC PANBRAKE

Models

PB-440A/T, PB-825A

Order Code S581A/T, Order Code S583B

PB-830A/T, PB-860T, PB-1030T

Order Code S584A/T, Order Code S586T, Order Code S585T

Edition No : HPB-04

Date of Issue : 11/2020

www.machineryhouse.com.au

MACHINE DETAILS

MACHINE	<input type="text" value="HYDRAULIC PANBRAKE"/>
MODEL NO.	<input type="text"/>
SERIAL NO.	<input type="text"/>
DATE OF MANF.	<input type="text"/>

Distributed by



www.machineryhouse.com.au
www.machineryhouse.co.nz

NOTE:

This manual is only for your reference. Owing to the continuous improvement of the Metalmaster machines, changes may be made at any time without obligation or notice. Please ensure the local voltage is the same as listed on the specification plate before operating this electric machine.



NOTE:

In order to see the type and model of the machine, please see the specification plate. Usually found on the back of the machine. See example (Fig.1)

METALMASTER
PRODUCT SPECIFICATION

MODEL:	<input type="text"/>
CAPACITY:	<input type="text"/>
SER. NO:	<input type="text"/>
MFG DATE:	<input type="text"/>
WEIGHT:	<input type="text"/>
VOLTS:	<input type="text"/>
MOTOR Kw:	<input type="text"/>

www.machineryhouse.com.au
Made in China

Fig.1

C O N T E N T S:

1. GENERAL MACHINE INFORMATION	
1.1 Specifications.....	4
1.2 Standard Equipment.....	4
2. IMPORTANT INFORMATION	
2.1 Safety Requirements.....	5
2.2 Features of the Machine.....	7
2.3 Lifting Instructions.....	8
3. INSTALLATION	
3.1 Base Foundation and Securing Points.....	9
3.2 Machine Leveling.....	10
3.3 Checking the Power Supply.....	10
3.4 Attaching the Accessories.....	11
3.5 Fill The Hydraulic Oil Tank.....	11
4. COMMISSIONING	
4.1 Preparation of the Machine.....	12
4.2 Check Clamp Safety Mute Stop.....	12
4.3 Commissioning Check List.....	12
5. MACHINE OPERATION	
5.1 Setting The Clamp Gap.....	13
5.2 Start Up.....	14
5.3 Bending.....	14
5.4 Controls.....	14
5.5 NC89 Controller Operation.....	15
5,6 BANNER - Touch Screen Operation.....	16
6. MAINTENANCE	
6.1 Type and frequency of Inspections.....	19
6.2 Lubrication Points.....	20
6.3 Changing Oil.....	21
6.4 Changing The Filter.....	21
6.5 Troubleshooting.....	22
Spare Parts.....	23
Risk Assessment.....	28

1. GENERAL MACHINE INFORMATION

1.1 SPECIFICATIONS

Order Code	S581A/T	S583B	S584A/T	S586T	S585T
Machine Type	PB-440A/T	PB-825A	PB-830A/T	PB-860T	PB-1030T
Bending Length (mm)	1300	2500	2500	2500	3050
Material Capacity Mild Steel (mm)	4	2.5	4	6	3.2
Stainless Steel (mm)	2	1.2	2	3	1.6
Bending Angle Indicator (deg)	0-120	0-120	0-120	0-125	0-120
Box Depth Of Fingers (mm)	230	215	205	205	205
Opening Height (mm)	140	140	140	140	140
Weight (kgs)	1250	1740	2900	3800	3730
System Pressure (Mpa)	5	5	5	12	5
Pan Movement Speed (mm/sec)	5	5	5	5	5
Clamp Movement Speed (mm. sec)	10	10	10	10	10
Oil Tank Volume (ltr)	60	40	60	60	60
Back Gauge Range (mm)	1000	1000	1000	1000	1000
Main Motor 3Ph 415v 50Hz (KW)	3.75	3.75	5.5	7.5	5.5

1.2. STANDARD EQUIPMENT

- Tools and instruction manual
- Back-gauge assembly
- Side guarding
- Foot switch and control panel

The above specifications were current at the time this manual was published, but because of our policy of continuous improvement, Metalmaster reserves the right to change specifications at any time and without prior notice, without incurring obligations.

2. IMPORTANT INFORMATION

2.1 SAFETY REQUIREMENTS

The purpose of the safety section of this manual is to inform operators and maintenance personnel of the precautions to be taken while operating or servicing the machine. The following are a few basic guidelines to follow, but as with any type of machinery, good judgment and a safe attitude should be applied at all times.



Safety glasses must be worn at all times in work areas. Earmuffs should be worn if the work area is noisy.



Sturdy footwear must be worn at all times in work areas.



Gloves must be worn when handling the material.



Long and loose hair must be contained with a net or under a hat

SAFETY CHECKS BEFORE OPERATING

- Locate and ensure you are familiar with all machine operations and controls.
- Take notice of any warning labels on the machine and do not remove them.
- Ensure all guards are fitted, secured and functional.
- Ensure working parts are well lubricated and the jaws and fingers are free of rust and dirt.
- Check workspaces and walkways to ensure there is no slip/trip hazards are present.
- Be aware of other people in the area. Ensure the area is clear before using equipment.

SAFETY CHECKS WHEN OPERATING

- Operate the machine only if all protective devices and guarding are mounted and effective.
- Remove the pan brake fingers that are in the way. Use only the pan brake fingers required to make the bend.
- Check that the material to be bent is the correct thickness.
- Ensure the panbrake fingers that have not been removed for an operation are seated securely and firmly tightened before the machine is used.
- Ensure your fingers and limbs are clear before operating the panbrake.
- Lower finger clamps to work slowly. Do not drop.
- Check the workpiece is secure.
- Keep clear of moving counterweight (where fitted).

POTENTIAL HAZARDS AND INJURIES

- Sharp edges and burrs.
- Squash/crush and pinch points.
- Impact from apron.

2.1 SAFETY REQUIREMENTS Cont.

DO NOT

- Do not use faulty equipment. Immediately report suspect machinery.
- Do not use a panbrake for bending metal that is beyond its capacity of thickness, or type.
- Do not attempt to bend rod, wire, strap or spring steel sheets.
- Do not remove the guards in front of the machine under any circumstances while the machine is in an operational mode.
- Do not operate the machine without proper adjustment according to sheet thickness.
- Do not bend material which has been welded or deformed.
- Do not use clamp fingers which are excessively damaged.

WHEN MAINTAINING THE MACHINE

- Shut off the machine completely before any repair work is carried out.
- Disconnect and tag the power supply if not required while doing maintenance
- The machine is to be serviced and/or be repaired only by the authorized personnel

PINCH POINT SAFETY WARNING

Machinery can pose a hazard with moving parts, conveyors, rollers and rotating shafts. Never reach into a moving machine. The machine must always be properly maintained. Always use the machine tool guards provided with your equipment. They act as a barrier between the moving parts and your body. In order to prevent accidents involving pinch points, the points listed below must be followed when using machinery

- Use the right tool for the job
- Identify possible pinch point hazards in your work area
- Concentrate on objects that move or are capable of moving.
- Ask yourself, "What will happen if this moves? Will I be in the path of that movement?"
- Be aware of pinch points created by objects that move and come into direct or close contact with fixed objects
- Be on guard whenever you put your hands, fingers, toes, or feet "between" anything.
- Discuss and point out pinch point hazards as part of your risk assessment.
- Make sure your hands are placed where you can see them



2.2. FEATURES OF THE MACHINE:

The electrical and hydraulic circuits of your machine are designed to allow operation with maximum safety. The following precautions are available on the machine for enhanced safety.

The Emergency stop button (engaging type) is found on the foot switch control unit. Once the button has been pressed to reset the emergency stop, the red button must be rotated to release the stop button to allow it to be raised to its normal position.

Foot Pedal Control

The foot pedals are used to activate the clamping mechanism

Main Controls

The main machine operating controls are located on the mobile unit.

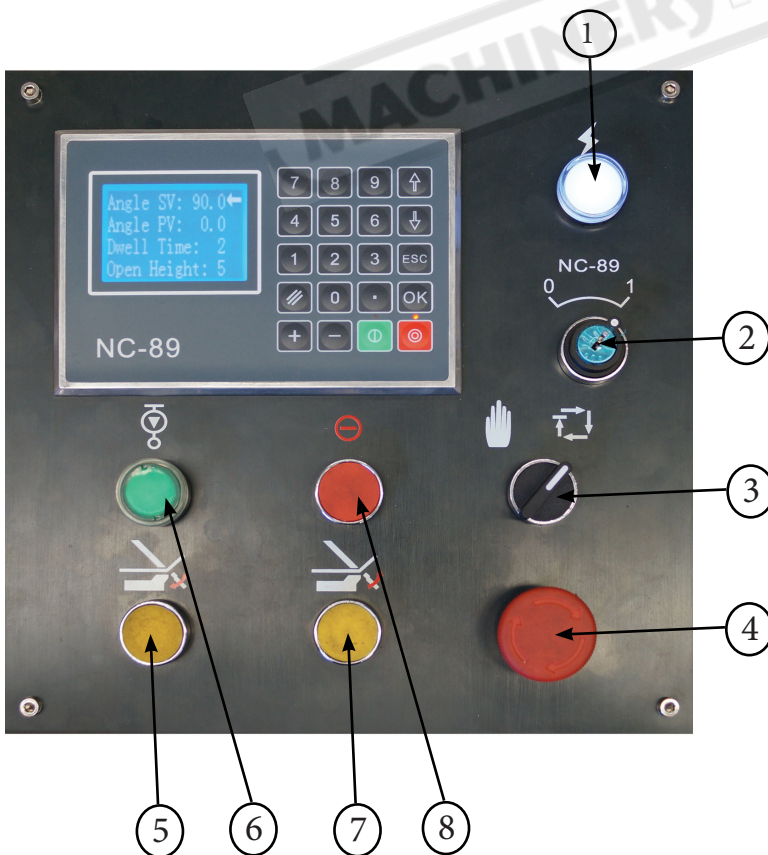
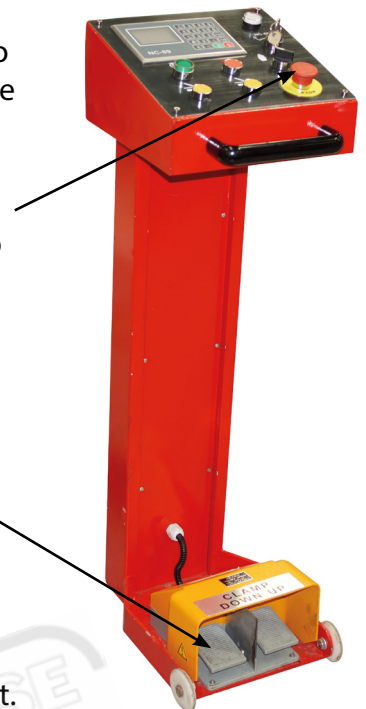

1	Power ON Light
2	Switches on the Controller
3	Manual or Cycle mode
4	Emergency Stop
5	Apron UP
6	Pump ON
7	Apron Down
8	Pump OFF

2.2 LIFTING INSTRUCTIONS

On the day that the machine arrives, make sure that a crane with sufficient capacity is available to unload the Panbrake from the vehicle. Make sure access to the chosen site is clear and that doors and ceilings are sufficiently high and wide enough to receive the machine.

To handle the Panbrake, use only the four sling holes located on the top of the end plates.

(Fig. 2.3) The slings should be positioned so the machine is level when lifted.

When using slings please take note of the sling angle and the loads that apply

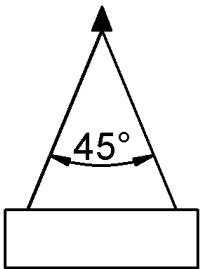

Fig 2.1.

When the slings are at a 45° angle then each sling will carry the equivalent of 50% of load weight. (Fig.2.1).

When the slings are at a 90° angle then each sling will carry a load weight on each sling the equivalent to 75% of the weight of the machine.

(Fig 2.2)

Note: Metalmaster recommend not to exceed 90° angle

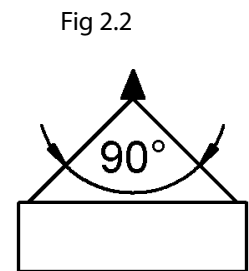

Fig 2.2

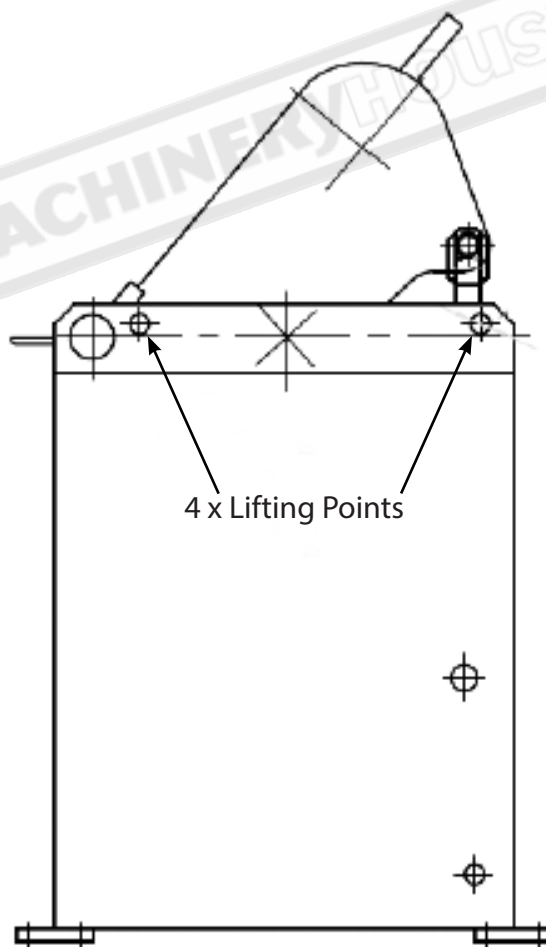

Fig. 2.3

3. INSTALLATION

The machine must be positioned and leveled where it is to be used, according to the Installation instructions in this manual.

The floor load, where the machine is to be installed, must be suitable for the weight of the machine.

3.1 BASE FOUNDATION AND SECURING POINTS

Before securing the machine a solid concrete base must be prepared to the specification of the machine.

The sizes for the bolt holes position are listed as A-B. (Check with your dealer before the machine arrives)

Fig. 2.5

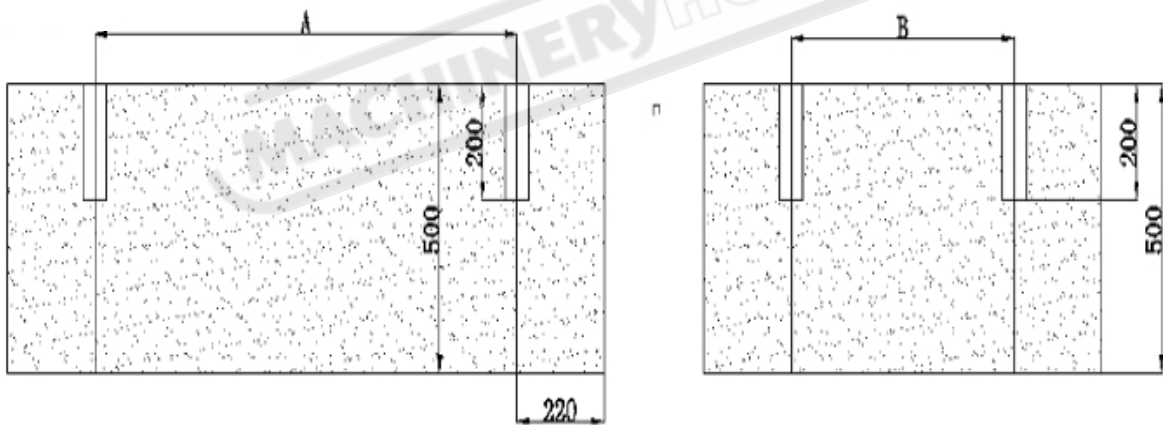

3.2 MACHINE LEVELING

To set your machine up so that it operates to optimum performance, apply the following procedure. After your panbrake has been anchored to a concrete slab floor, it then needs to be leveled. The leveling is performed using each of the screws on each pad.(Fig. 3.1).

Loosen the hold down bolts and place a level on the surface of the working table. Tolerances: 1000:0.30mm, for both axis.

Metal plates need to be placed under each jacking screw to distribute the load. Once the machine is level then tighten the hold down bolts. Re-check the level again.

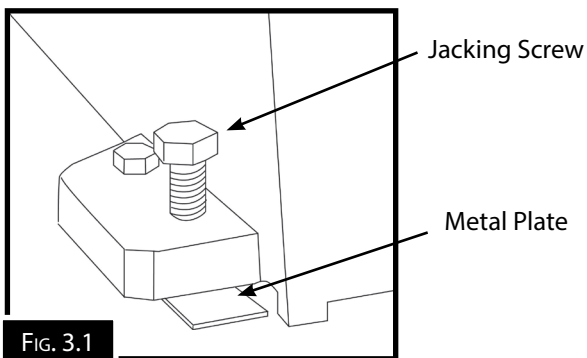

The machine must not rest on supports other than those defined in Fig. 3.1

3.3 CHECKING THE POWER SUPPLY

METALMASTER machines are supplied wired ready to run. Check the specification plate on the machine to confirm the correct voltage of the power supply.

The machine must be connected by a qualified and licensed electrician. Warranty could be voided if it is found that the connection was not carried out by a qualified electrician and problems occur.

Check the rotation of the motor. The motor needs to rotate clockwise as shown below.

If the direction is incorrect, stop the pump, isolate the machine and make changes to the wiring

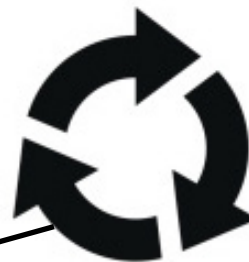

3.4 ATTACHING THE ACCESSORIES.

- Bolt on the arms that support the back gauge. Ensure they are square to the table. (Fig 3.2)
- Bolt on the apron safety guards (Fig 3.3)

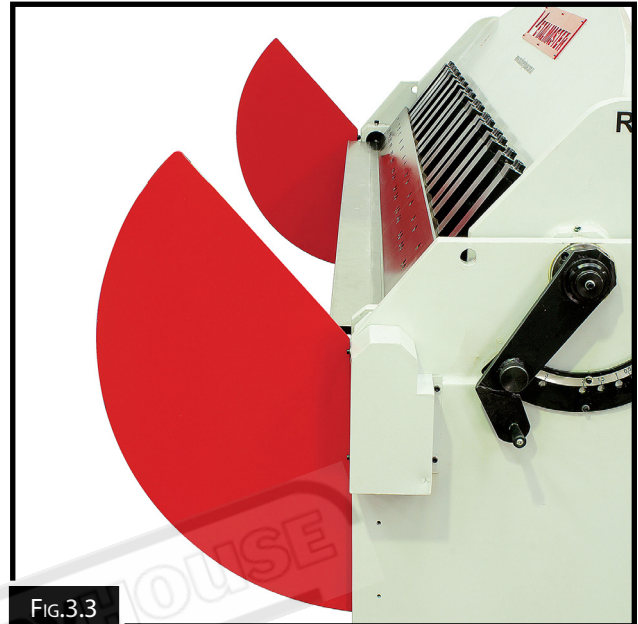
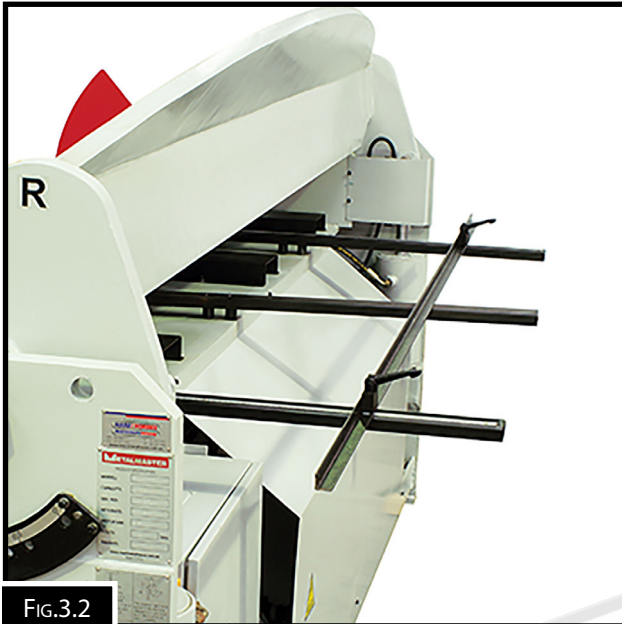

3.5 FILL THE HYDRAULIC OIL TANK.

When filling the tank with oil, make sure that the top of the tank is clean and free from dust and dirt.

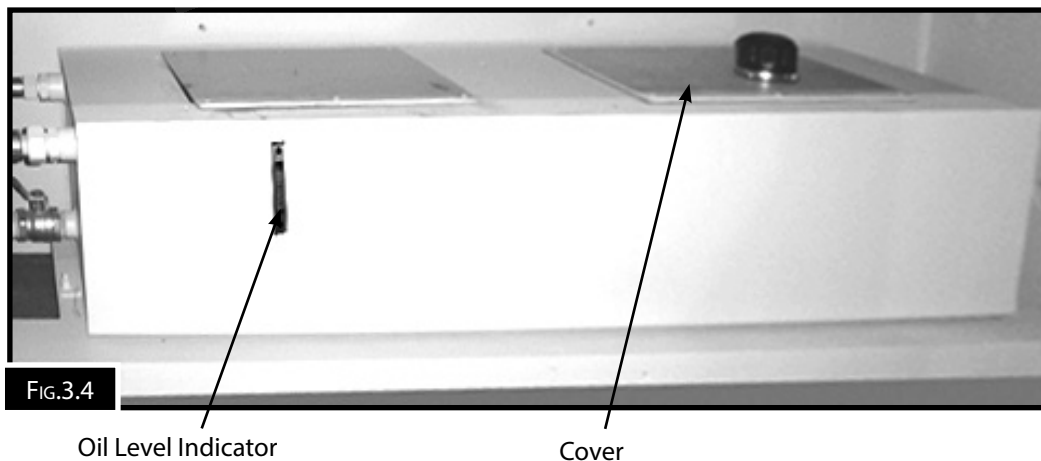

1. Remove the oil tank cover. (Fig.3.4)
2. Make sure the inside of the tank is clean and clear of any dirt
3. Using a pump, fill the tank with oil until the level reaches the centre mark of the oil indicator. Observation of the oil level indicator should be done regularly to ensure the oil is kept at the same level.

4. COMMISSIONING

4.1. PREPARATION OF THE MACHINE.

- Remove all wrapping and packing grease from the machine.
- Check the machine for loose bolts. Tighten as required.
- Inspect for oil leakage or loose fittings.
- Grease all grease nipples.
- Start pump and test Emergency stop operation
- Inform your service provider of any damage or faults with the machine.

4.2. CHECK CLAMP SAFETY MUTE STOP-

Press & hold the clamp down pedal so the clamp travels down continuously. It must stop 20-28mm above the bed. If it does not stop within the range adjust the micro switch located on the left rear of the machine. Release pedal and repress to complete clamping. (Fig. 4.1)

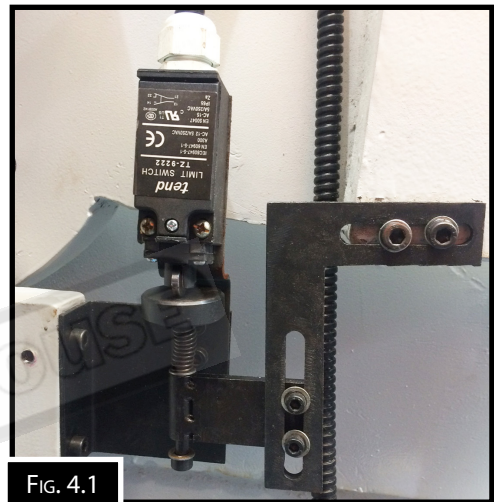

FIG. 4.1

4.3. COMMISSIONING CHECK LIST.

Before starting the machine the following checks must be carried out.

- Installation and machine preparation has been performed according to the manuals instructions.
- Fill the oil reservoir with 46 grade hydraulic oil and ensure that the oil filter breather cap is fitted
- All grease nipple points have been lubricated.
- Electrical earth fitted and power circuits, switches, and foot-pedal checked.
- Check power connections and any damage to wiring.
- Safety guards have been fitted securely
- Check pump rotation.
- Test Emergency stop to ensure it is operating correctly.
- Test controller operation.
- Test all mechanical operations on the machine.
- Test bend material and check quality of the bend.
- Tools, equipment and personnel are clear of the machine.
- Operation Manual on how to operate the machine has been read.

5. MACHINE OPERATION

5.1 SETTING THE CLAMP GAP

Before operating the machine the clamp gap needs to be set to match the material thickness. The Clamp gap must be set to a minimum of 1.5 x material thickness.

Example: If the material that is to be bent is 4mm then the clamp gap must be set to a minimum of 6mm.

Each panbrake may have different mechanisms for adjusting the clamp gap but the formula of 1.5 x Material Thickness must be maintained to prevent overload and possible damage

Some machines have a quick adjusting arm with pin positions marked 0-6. This represent the material thickness.

Example: If the material to be bent is 6mm then place the pin in position 6. (Fig. 5.2)

NOTE : This setting must be done on both sides.

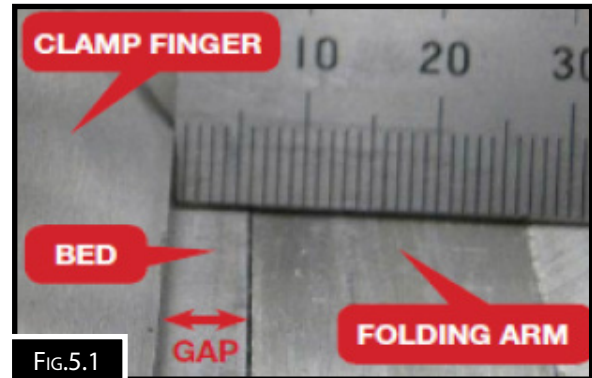

FIG.5.1



FIG.5.2

You may have to use a combination of top clamp adjustment and apron adjustment. Example: If bending 6mm aluminium with the clamping position 4, the apron must be dropped down 3mm to make the total gap of 9mm (1.5 x 6mm = 9mm) (Fig. 5.3)

Note ! The locking bolts on the apron must be released before adjusting, then tightened when the correct height is reached.



FIG.5.3

RETURN LENGTH - LIMITATION

Caution - There is a minimum "Return Length" of 15 x Thickness of Material when bending thicker material over 1mm. Damage could occur to the machine if the return is too short. (Fig. 5.4)

Example: If bending 4mm the minimum return length must be 60mm

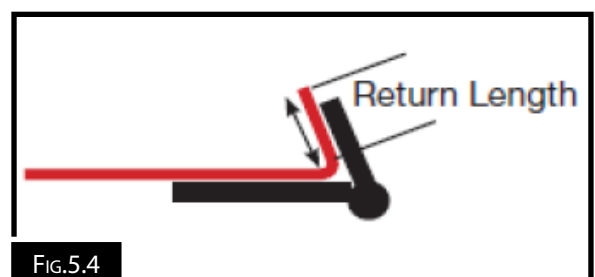

FIG.5.4

5.2 START UP

- a. Check that the electrical supply has been connected.
- b. Check that the hydraulic tank has been filled with hydraulic oil.
- c. Ensure that the emergency stop button is in the released position.
- d. Ensure the isolating switch is on and power light is illuminated
- e. Press the hydraulic pump button to start the electric motor.

5.3 BENDING

- a. Adjust the bend angle adjuster according to your requirements.
- b. Ensure the clamp gap has been set according to the thickness of the plate.
- c. Once the steel plate is in position for bending then the choice of inching or cycle mode can be selected.
- d. Do not bend material which has been welded or deformed.

5.4 CONTROLS

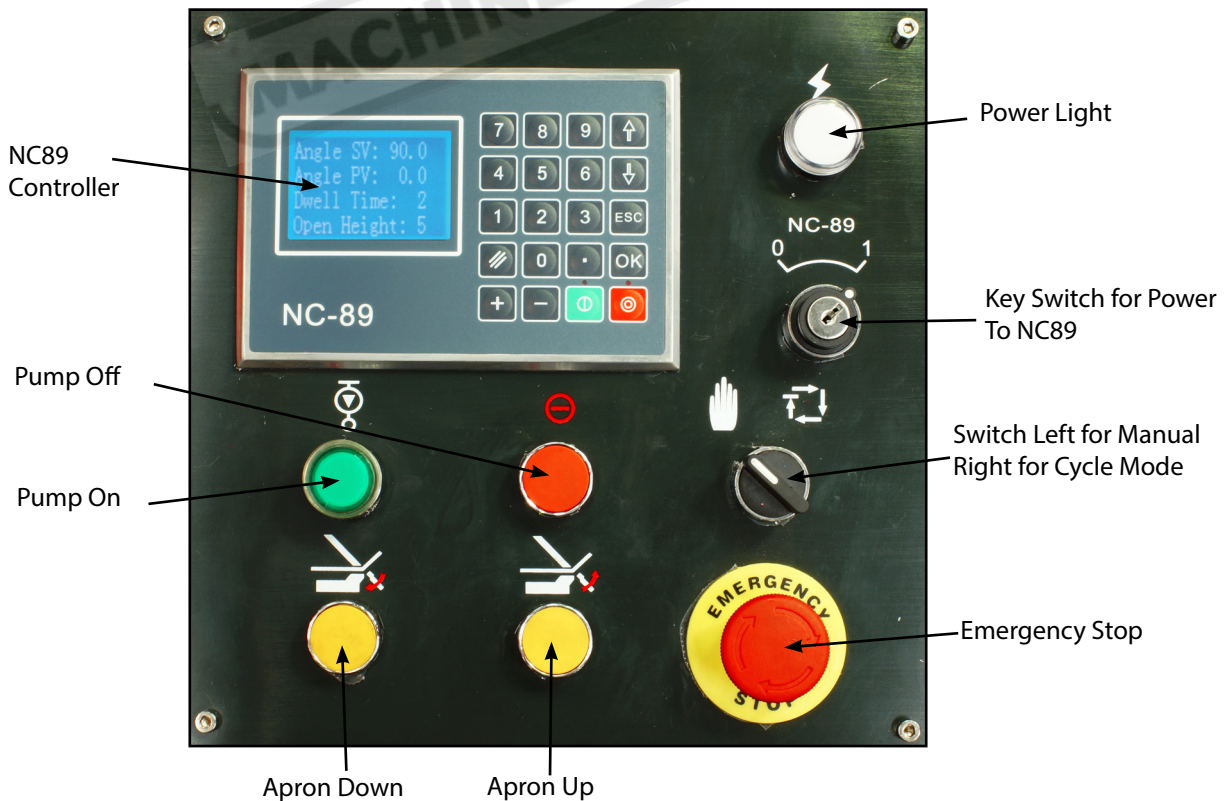

NC-89 Panbrake Controller Operation

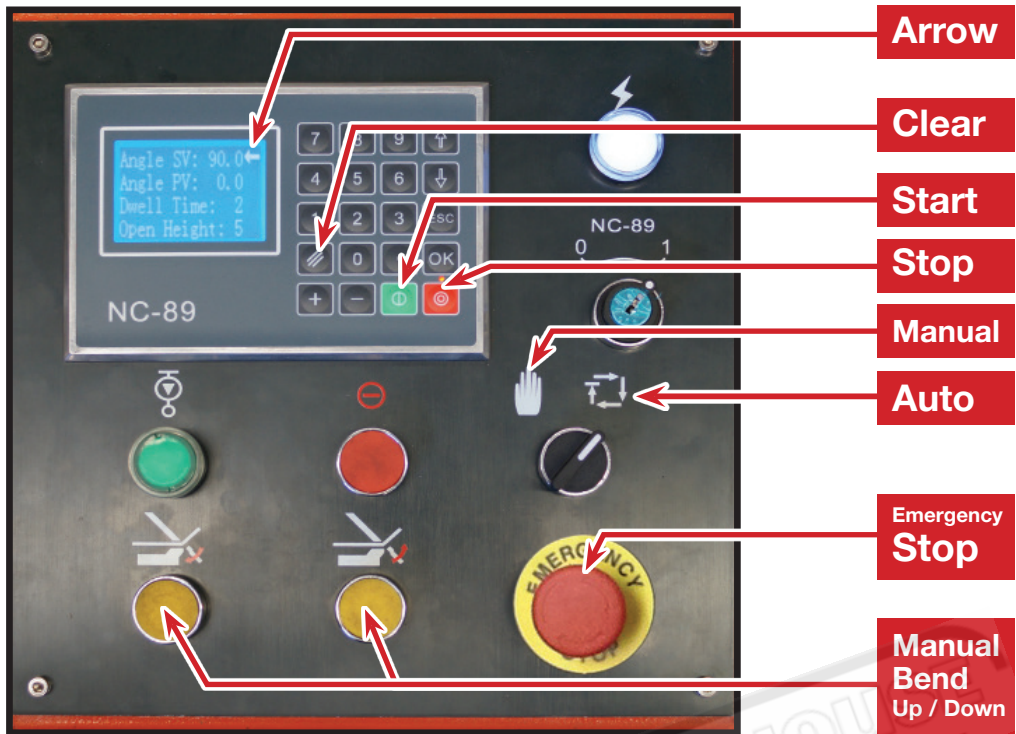

Angle SV: Desired programmed angle.

Operation: Move Arrow to **Angle SV**, clear value,  enter desired angle value. Example: 5 = 5°, and press .

Angle PV: Actual position of apron.

Operation: Angle PV is a digital readout for the apron angle as the apron moves. This is visual only and can not be modified.

Dwell Time: Desired time apron will dwell after it has reached Angle SV. Auto function only

Operation: Move Arrow to **Dwell Time**, clear value,  enter desired value. Example: 2 = 2 seconds, and press .

Open Height: Desired height the clamp opens after apron returns to zero. Auto function only

Operation: Move Arrow to **Open Height**, clear value,  enter desired value. Example: 3 = 3 seconds, and press .

Manual Bend: Switch mode to manual. Example: Enter 90° in **Angle SV**. Clamp material and use the Up Manual Button to bend material. Button can be released at any time and apron will stop. NC-89 with stop apron at 90°. Release button and bend more/less or return back to 0° and un-clamp with foot pedal.

Auto Bend: Switch mode to Auto. Example: Enter 90° in **Angle SV**, Enter 2 sec in **Dwell Time**, Enter 3 sec in **Open Height**. Clamp material and press green start button on NC-89. Apron will automatically bend up to 90°, dwell for 2 seconds, return to 0° and then clamp will open for 3 seconds. Job complete.

WARNING: The apron will automatically bend up once the  start button is pressed.

BANNER - Panbrake Touch Screen Operation

HOME page: *This is the main page to access all the bending screens.*

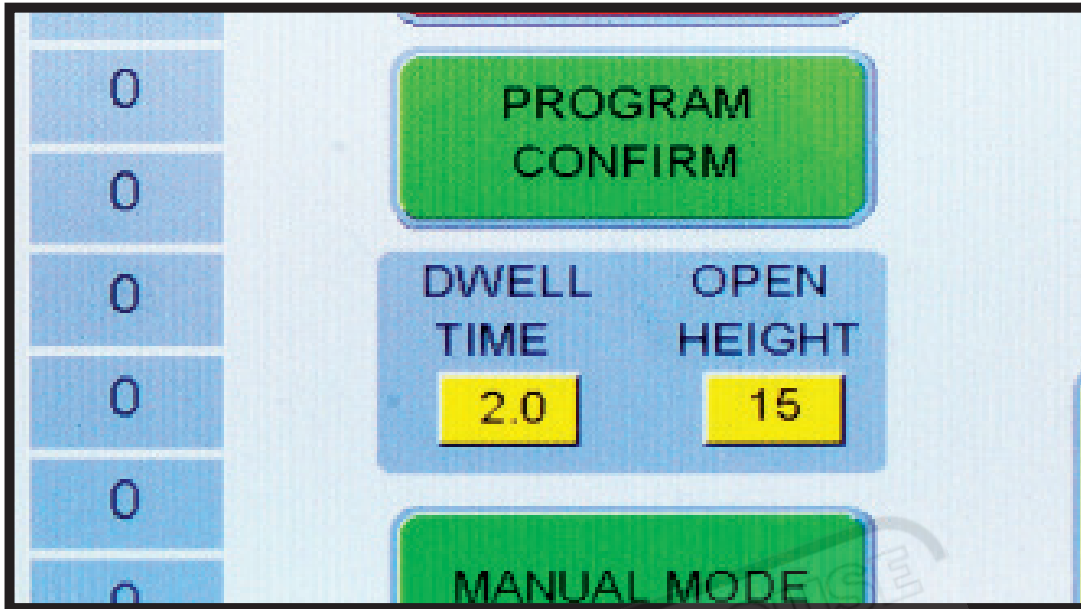

Touch Screen: Touch any icon to navigate the controller or operate apron.

PUMP ON: Press the PUMP ON icon to turn the pump on for any bending operations.

MANUAL MODE: *Press MANUAL MODE icon to access this screen.*

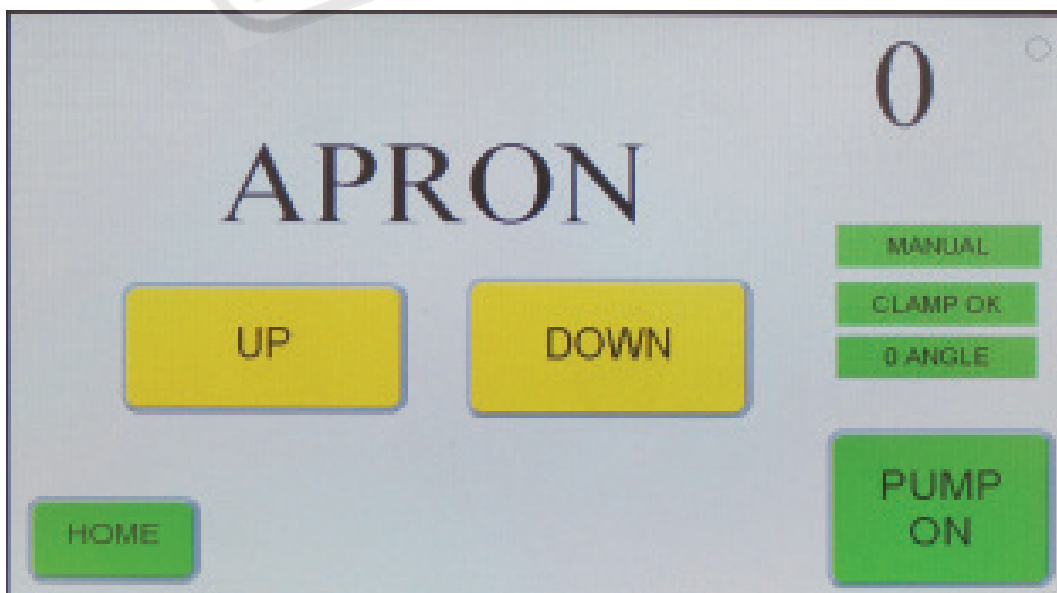



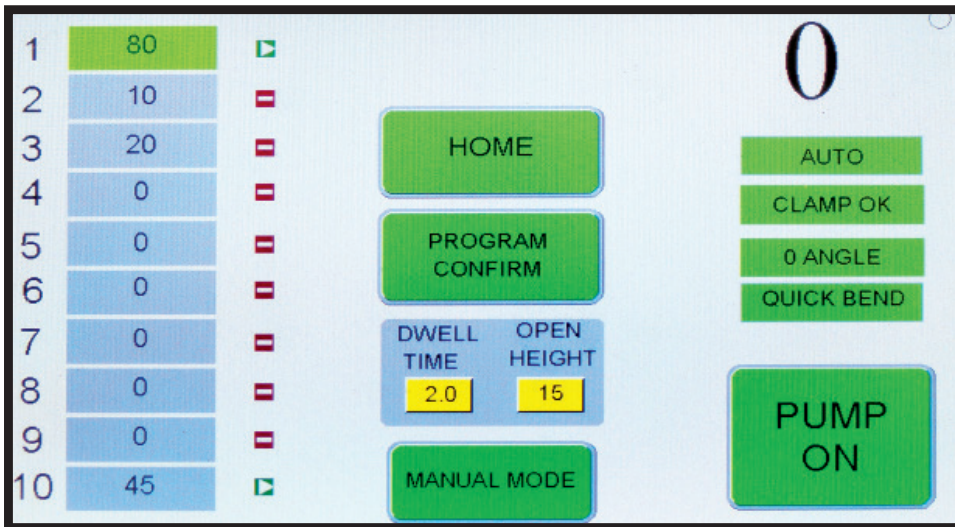

Operation: Clamp job with foot pedal. When CLAMP OK is green, means the clamp is in position to allow bending to start. Pressing UP / DOWN will operate apron. Apron angle will count as the apron moves up or down.

QUICK BEND: Press **QUICK BEND** icon to access this screen.





WARNING: The apron will automatically bend up once the start button is pressed.

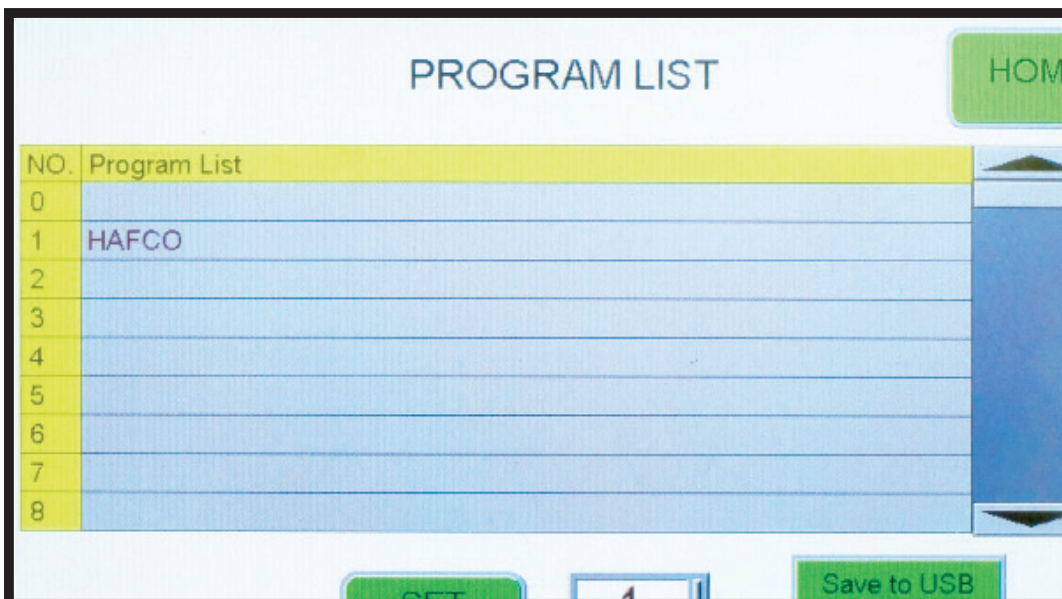

Operation: Touching icon  will change to  which indicates bend is ON. Touching  will bring up a screen for you to change the value. If desired you may change the DWELL TIME and OPEN HEIGHT. Once all values are correct press PROGRAM CONFIRM to load program (This will turn RED which means the program has been loaded). Clamp job with foot pedal and Press the start button  to start bending. The apron will automatically bend up to the programmed angle, dwell for set value, return back down to 0 position, then the clamp will open automatically to the set open height. Repeat process for next bend.

PROGRAM LIST: Press **EDIT PROGRAM** icon to access this screen.



Operation: Press  to select a PROGRAM number. Press SET to change bend data or press HOME to load the program onto the home page.

PROGRAM MODIFICATION:

Press the SET icon in PROGRAM LIST to access this screen.



WARNING: The apron will automatically bend up once the  start button is pressed.

Operation: Press NAME to enter a name. To make BEND 01 bend to 90° Press **090** ANGLE and enter 90. OFFSET is for bending thicker material, Entering 5 in OFFSET will make apron bend to 95°. Pressing delete **Del** will skip the bend. Press EXIT to return to HOME page. Once on HOME page press PROGRAM CONFIRM to load program then press the start button  to start bending. The apron will automatically bend up to the programmed angle, dwell for set value, return back down to 0 position, then the clamp will open automatically to the set open height. Repeat process for next bend.

USB Device: Press the Save to USB icon to access this screen
This screen is for saving or loading programs to or from a USB device.

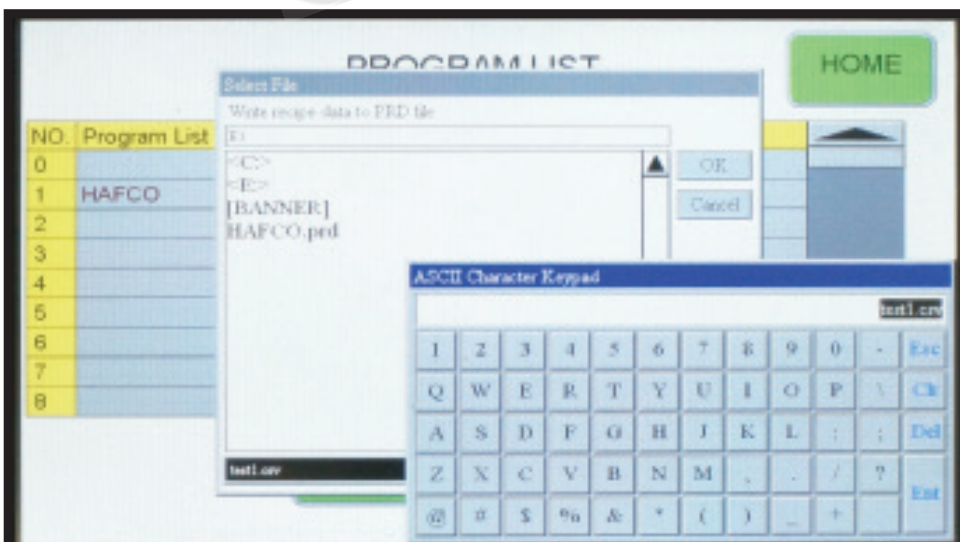

Operation: To SAVE a program: Press and hold **Save to USB** on the PROGRAM LIST screen for 3 seconds to activate the “Save to USB” function. Press on the test1.csv to rename your program, press “ent” to save your program then press OK. To LOAD a program: Press and hold **Read from USB** on the PROGRAM LIST screen for 3 seconds to activate the “Read from USB” function. Press on the eg: HAFCO.prd file and press OK.

6. MAINTENANCE

6.1 TYPE AND FREQUENCY OF INSPECTIONS

Inspection	Frequency	Responsible
Lubrication of all grease points	See Lubrication points (Section 4.2)	Operator
Lubrication of clamp fingers and machine surfaces	Daily	Operator
Guards for physical damage	Daily	Operator
Machine fixing bolts against loosening	Weekly	Operator
Oil Leakage in cylinders	Weekly	Operator
Oil leakages in hoses, pipes and hydraulic parts	Weekly	Operator
Hydraulic fluid levels	Weekly	Operator
Cylinder connecting bolts against loosening	Weekly	Operator
Safety and limit switches against loosening	Weekly	Operator
Electrical terminal connections	Annually	Electrician

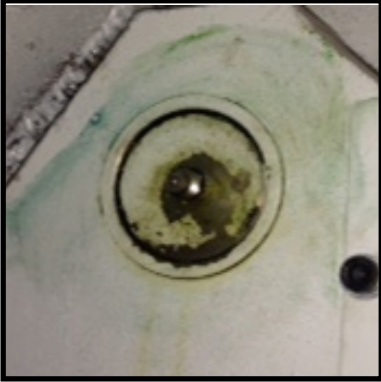
6.2 LUBRICATION POINTS

Grease Points X 2 Every 8Hrs



Grease Points X 2 Every 8Hrs



Grease Points X 2 Every 8Hrs



Grease Points X 2 Every 8Hrs

6.3 CHANGING OIL

The efficiency of the Metalmaster machine relies on the hydraulic system being well maintained

All precautions must be taken to keep the hydraulic system clean at all times.



FIG. 6.5

Oil Level Indicator

Cover

1. Remove the oil tank cover. (Fig. 6.5)
2. Using an appropriate pump, drain out the old oil completely. Be sure nothing is left
3. Using a pump, fill the tank with new 46 grade hydraulic oil until the oil reaches the middle mark on the oil indicator. Check the oil level regularly to make sure it is always kept at the same level.
4. When changing oil, keep the oil tank clean and free of dirt at all times..
5. Oil must be changed after first 200 working hours of use, and then after every 1000 working hours. (See: Lubrication Diagram) .

4.4 CHANGING THE FILTER

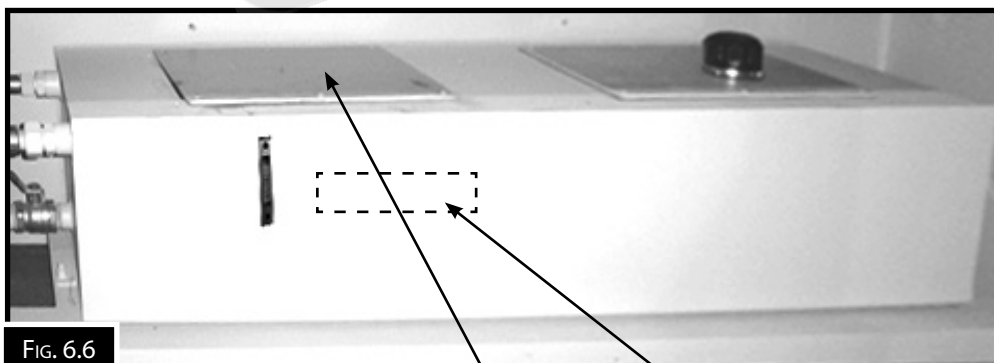

FIG. 6.6

Cover

1. Remove the cover on the oil tank.
2. Unscrew the old filter from its place inside the oil tank.
3. Screw the new filter into its place in the tank and replace the cover. (Fig 6.6)

NOTE: The suction filter element must be cleaned after first 200 hours of use, and then after every 1000 working hours. Replace if damaged.

6.5 TROUBLESHOOTING

PROBLEM	POSSIBLE CAUSES	CORRECTION
Material bend is uneven	1. Clamp setting wrong for the material thickness. 2. Finger edges are uneven	Re-adjust cam settings Adjust pan clearance Adjust fingers
No Clamping	Pressure relief valve is blocked Failure in the pressure relief valve Directional valve is blocked Failure of directional valve Suction filter is blocked Pump failure Leakage in the pipes or cylinder	* Clean valve *Change valve * Clean valve * Change valve * Clean filter * Check pump and change if necessary * Find the leaks and repair *Press reset button
Apron does not operate	Low pressure in lifting cylinders Leakage in lifting cylinders	* Check system pressure *Replace piston seal * Press Reset button
Oil leaking from cylinder	Gland seal is damaged	*Change seal
Oil leaking from fittings	Loose fittings	*Tighten fittings

SPARE PARTS SECTION

HYDRAULIC PANBRAKE

Models

PB-440A/T, PB-825A

Order Code S581A/T, Order Code S583B

PB-830A/T, PB-860T, PB-1030T

Order Code S584A/T, Order Code S586T, Order Code S585T

Edition No : HPB-04

Date of Issue : 11/2020

The following section covers the spare parts diagrams and lists that were current at the time this manual was originally printed. Due to continuous improvements of the machine, changes may be made at any time without notification.

HOW TO ORDER SPARE PARTS

1. Have your machines **model number, serial number & date of manufacture** on hand, these can be found on the specification plate mounted on the machine
2. A scanned copy of your parts list/diagram with required spare part/s identified.

NOTE: SOME PARTS MAY ONLY BE AVAILABLE AS AN ASSEMBLY

3. Go to www.machineryhouse.com.au/contactus and fill out the inquiry form attaching a copy of scanned parts list.

CONTENTS

A. Hydraulic Circuit Diagram.....	24
B. Primary Electric Circuit Diagram.....	25
C. NC-89 Circuit Diagram.....	26
Risk Assessment.....	28

A. HYDRAULIC CIRCUIT DIAGRAM

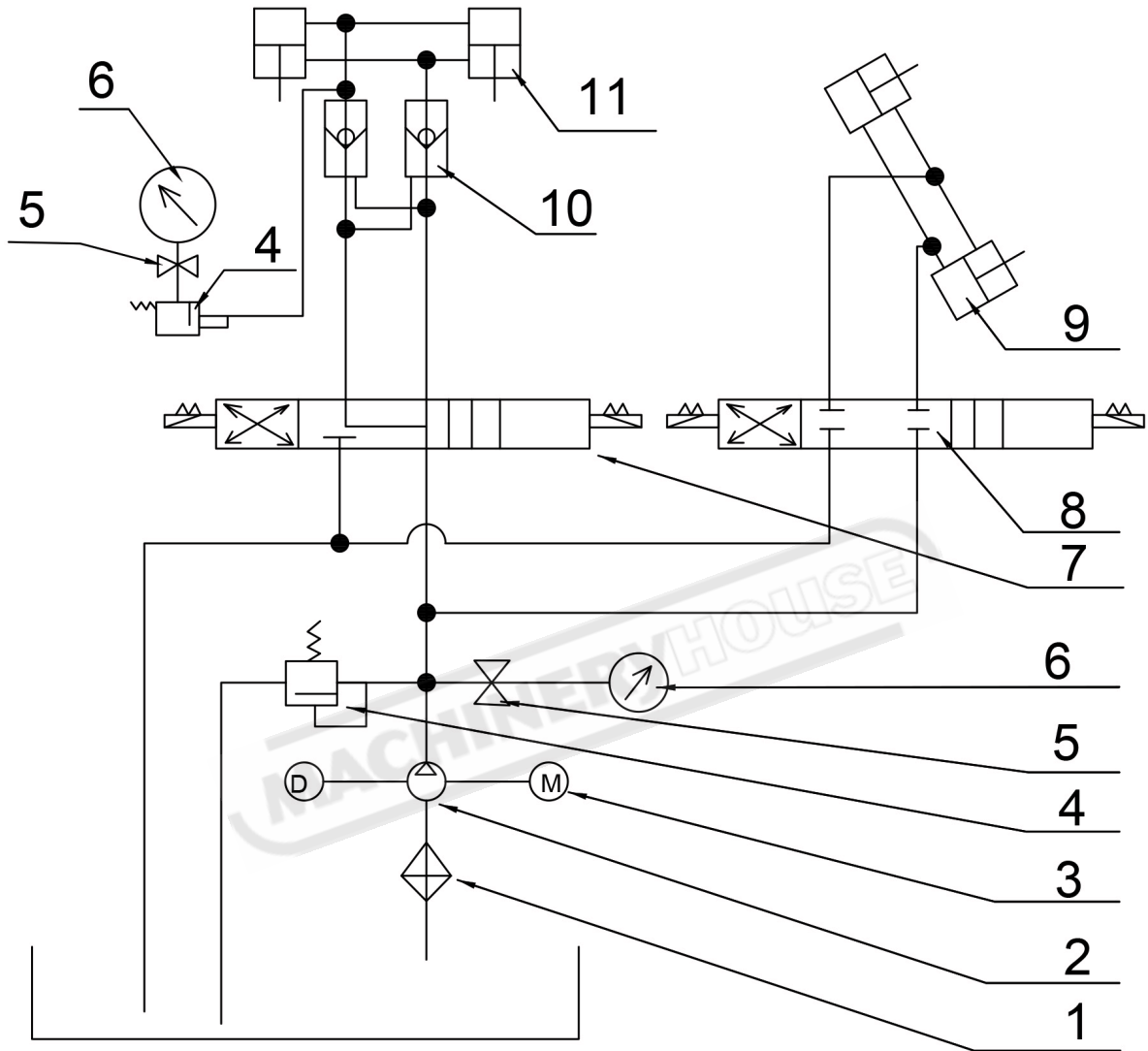

1. Filter
2. Oil Pump
3. Motor
4. Pressure Regulator Control Valve
5. Shut Off Valve
6. Pressure Gauge
7. Directional Control Valve
8. Directional Control Valve
9. Apron Cylinder
10. Position One Way Valve
11. Clamp Cylinder

C. NC89 CIRCUIT DIAGRAM

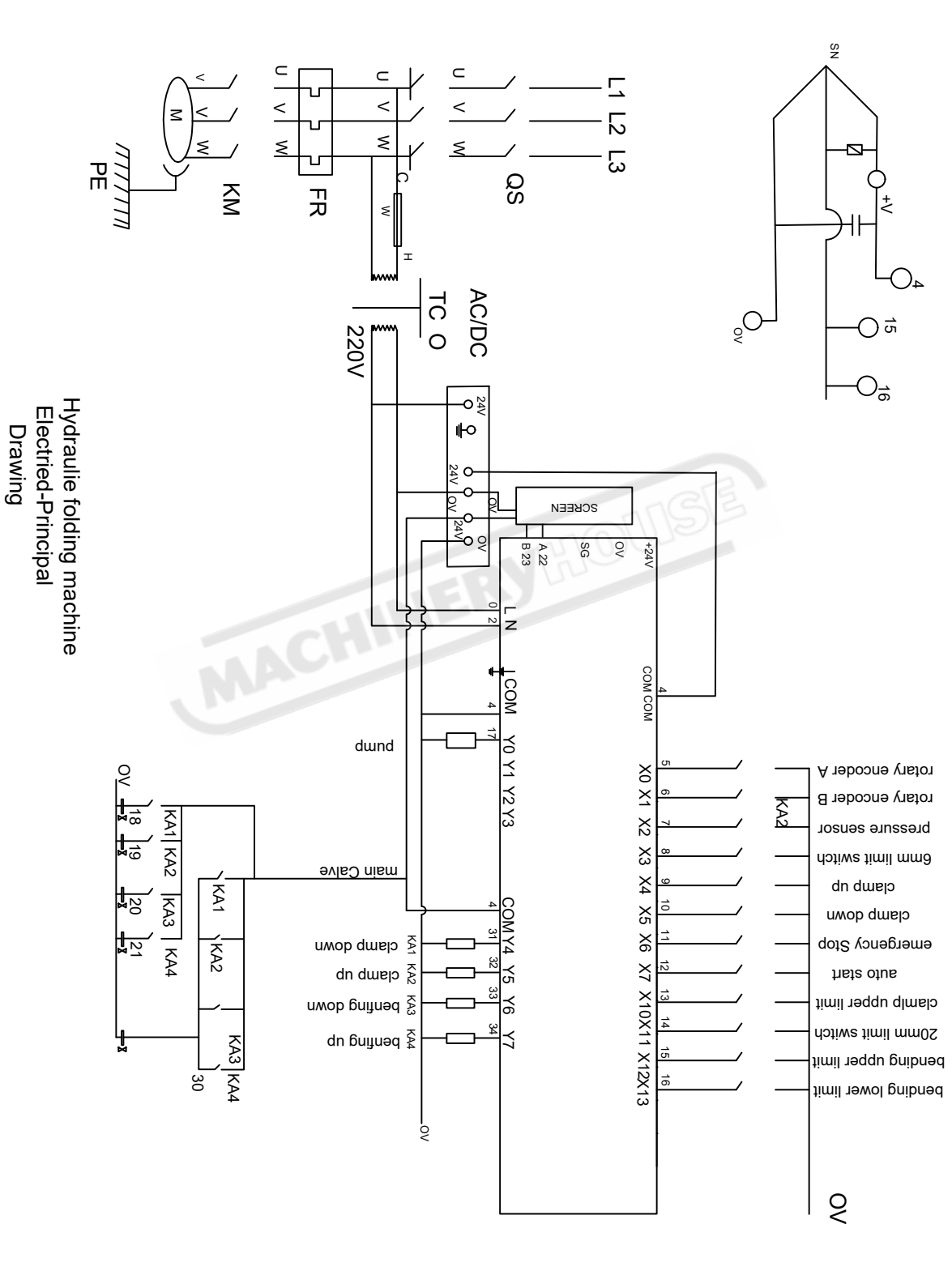

C. NC89 CIRCUIT DIAGRAM Cont.

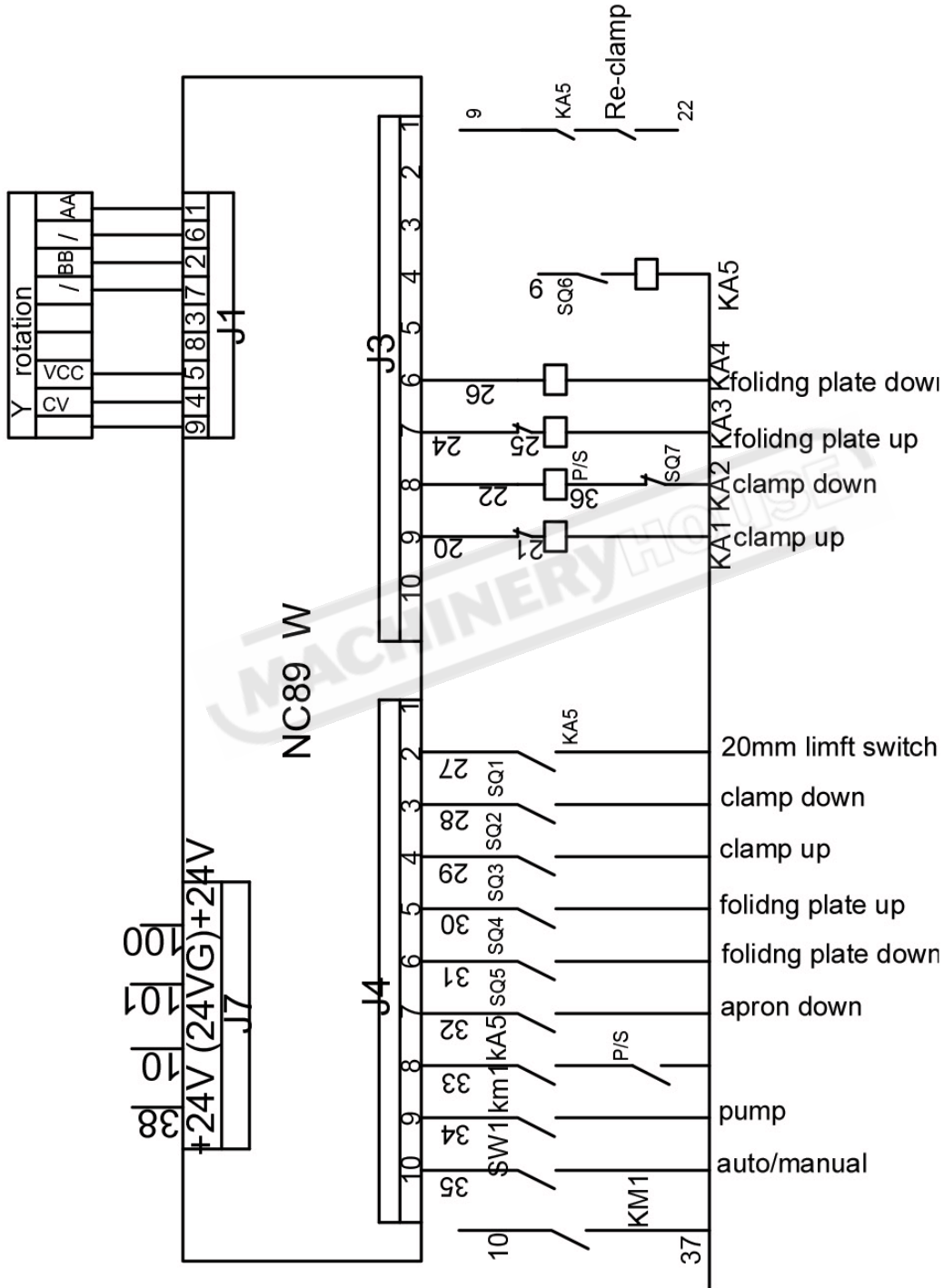

WARNING

General Machinery Safety Instructions

Machinery House
requires you to read this entire Manual before using this machine.

- 1. Read the entire Manual before starting machinery.** Machinery may cause serious injury if not correctly used.
- 2. Always use correct hearing protection when operating machinery.** Machinery noise may cause permanent hearing damage.
- 3. Machinery must never be used when tired, or under the influence of drugs or alcohol.** When running machinery you must be alert at all times.
- 4. Wear correct Clothing.** At all times remove all loose clothing, necklaces, rings, jewelry, etc. Long hair must be contained in a hair net. Non-slip protective footwear must be worn.
- 5. Always wear correct respirators around fumes or dust when operating machinery.** Machinery fumes & dust can cause serious respiratory illness. Dust extractors must be used where applicable.
- 6. Always wear correct safety glasses.** When machining you must use the correct eye protection to prevent injuring your eyes.
- 7. Keep work clean and make sure you have good lighting.** Cluttered and dark shadows may cause accidents.
- 8. Personnel must be properly trained or well supervised when operating machinery.** Make sure you have clear and safe understanding of the machine you are operating.
- 9. Keep children and visitors away.** Make sure children and visitors are at a safe distance for you work area.
- 10. Keep your workshop childproof.** Use padlocks, Turn off master power switches and remove start switch keys.
- 11. Never leave machine unattended.** Turn power off and wait till machine has come to a complete stop before leaving the machine unattended.
- 12. Make a safe working environment.** Do not use machine in a damp, wet area, or where flammable or noxious fumes may exist.
- 13. Disconnect main power before service machine.** Make sure power switch is in the off position before re-connecting.
- 14. Use correct amperage extension cords.** Undersized extension cords overheat and lose power. Replace extension cords if they become damaged.
- 15. Keep machine well maintained.** Keep blades sharp and clean for best and safest performance. Follow instructions when lubricating and changing accessories.
- 16. Keep machine well guarded.** Make sure guards on machine are in place and are all working correctly.
- 17. Do not overreach.** Keep proper footing and balance at all times.
- 18. Secure workpiece.** Use clamps or a vice to hold the workpiece where practical. Keeping the workpiece secure will free up your hand to operate the machine and will protect hand from injury.
- 19. Check machine over before operating.** Check machine for damaged parts, loose bolts, Keys and wrenches left on machine and any other conditions that may effect the machines operation. Repair and replace damaged parts.
- 20. Use recommended accessories.** Refer to instruction manual or ask correct service officer when using accessories. The use of improper accessories may cause the risk of injury.
- 21. Do not force machinery.** Work at the speed and capacity at which the machine or accessory was designed.
- 22. Use correct lifting practice.** Always use the correct lifting methods when using machinery. Incorrect lifting methods can cause serious injury.
- 23. Lock mobile bases.** Make sure any mobile bases are locked before using machine.
- 24. Allergic reactions.** Certain metal shavings and cutting fluids may cause an allergic reaction in people and animals, especially when cutting as the fumes can be inhaled. Make sure you know what type of metal and cutting fluid you will be exposed to and how to avoid contamination.
- 25. Call for help.** If at any time you experience difficulties, stop the machine and call you nearest branch service department for help.

WARNING

Hydraulic Panbrake Safety Instructions

Machinery House
requires you to read this entire Manual before using this machine.

- 1. Maintenance.** Make sure the Panbrake is turned off and disconnect from the main power supply and make sure all moving parts have come to a complete stop before any inspection, adjustment or maintenance is carried out.
- 2. Panbrake Condition.** Panbrake must be maintained for a proper working condition. Never operate a Panbrake that has low oil levels, damaged or worn parts. Scheduled routine maintenance should be performed on a scheduled basis.
- 3. Tooling Condition.** Never operate a Panbrake with damaged or badly worn tooling. Replace if required.
- 4. Pump Direction.** Pump rotation must be in arrow direction otherwise the pump will be damaged.
- 5. Hand Hazard.** Do not insert or extend your hands in between bending tools, under any circumstances, while the machine is in operation mode. Serious injury can occur.
- 6. Gloves & Glasses.** Always wear leather gloves and approved safety glasses when using this machine.
- 7. Authorized and trained personnel.** The machine must be operated by authorized and trained personnel. The machine is designed to be operated by a single user. Using the machine with more than one operator is forbidden, except for certain maintenance situations.
- 8. Power outage.** In the event of a power failure during use of the machine, turn off all switches to avoid possible sudden start up once power is restored.
- 9. Work area hazards.** Keep the area around the Panbrake clean from oil, tools, objects & chips. Pay attention to other persons in the area and know what is going on around the area to ensure unintended accidents. Do not access the rear of machine, while the machine is working
- 10. Guards.** Operate machine only with all protective devices and guarding.
- 11. Overloading Panbrake.** Do not exceed the rated capacity of the machine. Refer to the manual for correct capacities.
- 12. Warning Labels.** Take note of any warning labels on the machine and do not remove them.
- 13. Operation.** During the bending process, the workpiece may leap up. Therefore, the material must be handled carefully.
- 14. Emergency stop.** Use the emergency stop button in case of any emergency.
- 15. Level machine.** Level the machine on a flat concrete surface by using a spirit level.
- 16. Floor load for Installation.** The permissible floor load, where the machine is to be installed, must be accounted for.
- 17. Hearing protection and hazards.** Always wear hearing protection as noise generated from machine and workpiece can cause permanent hearing loss over time.
- 18. Heating Material.** Heating metal with a torch while the metal is in the bending brake will weaken the fingers.
- 19. Pinching.** Prevent pinching by lowering the panbrake fingers when not in use.
- 20. Call for help.** If at any time you experience difficulties, stop the machine and call your nearest branch service department for help.

PLANT SAFETY PROGRAM

NEW MACHINERY HAZARD IDENTIFICATION, ASSESSMENT & CONTROL

Hydraulic Panbrake

Developed in Co-operation Between A.W.I.S.A and Australia Chamber of Manufactures
This program is based upon the Safe Work Australia, Code of Practice - Managing Risks of Plant in the Workplace (WHSA 2011 No10)

Item No.	Hazard Identification	Hazard Assessment	Risk Control Strategies <small>(Recommended for Purchase / Buyer / User)</small>
B	CRUSHING	MEDIUM	Secure & support work material. Keep hands clear of folder blades when clamping.
C	CUTTING, STABBING, PUNCTURING	MEDIUM	Wear gloves to prevent cuts from sharp material offcuts. Care must be taken when handling folder blades.
D	SHEARING	MEDIUM	Body parts should be kept clear of moving parts. Isolate power to machine prior to any checks or maintenance. Do not adjust or clean until machine has fully stopped.
F	STRIKING	MEDIUM	Ensure guards are secured properly. Wear safety glasses. Ensure blade fingers are secured to clamp beam. Keep clear of bending material.
H	ELECTRICAL	MEDIUM	Ensure clamp beam is correctly adjusted. Machine should be installed & checked by a Licensed Electrician. All electrical enclosures should only be opened with a tool that is not to be kept with the machine.
O	OTHER HAZARDS, NOISE.	LOW	Wear hearing protection as required.
Plant Safety Program to be read in conjunction with manufactures instructions			



www.machineryhouse.com.au



www.machineryhouse.co.nz

Authorised and signed by:
Safety officer:



Manager:



Revised Date: 12th March 2012